

## Product Summary

$V_R = 650\text{ V}$   
 $I_F = 20\text{ A}$  ( $T_C=135^\circ\text{C}$ )  
 $Q_c = 42\text{ nC}$  ( $V_R=400\text{ V}$ )

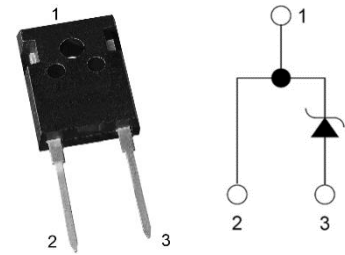

TO-247-2

## Features

- Zero Forward/Reverse Recovery Current
- High Blocking Voltage
- High Frequency Operation
- Positive Temperature Coefficient on  $V_F$
- Temperature Independent Switching Behavior
- 100% avalanche tested

## Benefits

- Higher System Efficiency
- Parallel Device Convenience without thermal runaway
- Higher Temperature Application
- No Switching loss
- Hard Switching & Higher Reliability
- Environmental Protection

## Applications

- Motor Drives
- Solar Inverters
- AC/DC converters
- DC/DC converters
- Uninterruptable power supplies

## Maximum Ratings ( $T_C=25^\circ\text{C}$ unless otherwise specified)

Parameter	Symbol	Test conditions	Value	Unit
Peak Repetitive Reverse Voltage	$V_{RRM}$		650	V
Peak Reverse Surge Voltage	$V_{RSM}$		650	V
DC Blocking Voltage	$V_R$		650	V
Continuous Forward Current	$I_F$	$T_C=25^\circ\text{C}$ $T_C=135^\circ\text{C}$ $T_C=150^\circ\text{C}$	43 20 15	A
Non repetitive Forward Surge Current	$I_{FSM}$	$T_C = 25^\circ\text{C}$ , $t_p=10\text{ ms}$ , Half Sine Pulse $T_C = 110^\circ\text{C}$ , $t_p=10\text{ ms}$ , Half Sine Pulse	110 100	A
Repetitive peak Forward Surge Current	$I_{FRM}$	$T_C = 25^\circ\text{C}$ , $t_p=10\text{ ms}$ , Freq = 0.1Hz, 100 cycles, Half Sine Pulse $T_C = 110^\circ\text{C}$ , $t_p=10\text{ ms}$ , Freq = 0.1Hz, 100 cycles, Half Sine Pulse	100 90	A
Total power dissipation	$P_D$	$T_C=25^\circ\text{C}$	166	W
Operating Junction Temperature	$T_J$		-55 to 175	$^\circ\text{C}$
Storage Temperature	$T_{STG}$		-55 to 175	$^\circ\text{C}$

Stresses exceeding those listed in the Maximum Ratings table may damage the device. If any of these limits are exceeded, device functionality should not be assumed, damage may occur and reliability may be affected.

## Electrical Characteristics

Parameter	Symbol	Test conditions	Min	Typ	Max	Unit
DC Blocking Voltage	$V_{DC}$	$T_J = 25^\circ C$	650			V
Forward Voltage	$V_F$	$I_F = 20A, T_J = 25^\circ C$		1.45	1.75	V
		$I_F = 20A, T_J = 125^\circ C$		1.63		
		$I_F = 20A, T_J = 175^\circ C$		1.79		
Reverse Current	$I_R$	$V_R = 650V, T_J = 25^\circ C$		1.2	70	$\mu A$
		$V_R = 650V, T_J = 125^\circ C$		6		
		$V_R = 650V, T_J = 175^\circ C$		18		
Total Capacitive Charge	$Q_C$	$V_R = 400V$		42		nC
Total Capacitance	C	$V_R = 1V, T_J = 25^\circ C,$ Freq = 1MHz		701		pF
		$V_R = 200V, T_J = 25^\circ C,$ Freq = 1MHz		81		
		$V_R = 400V, T_J = 25^\circ C,$ Freq = 1MHz		64		

Note: This is a majority carrier diode, so there is no reverse recovery charge

## Thermal Characteristics

Parameter	Symbol	Condition	Min	Typ	Max	Unit
Thermal Resistance	$R_{th(j-c)}$	junction-case		0.9		$^\circ C/W$

## Typical Electrical Curves

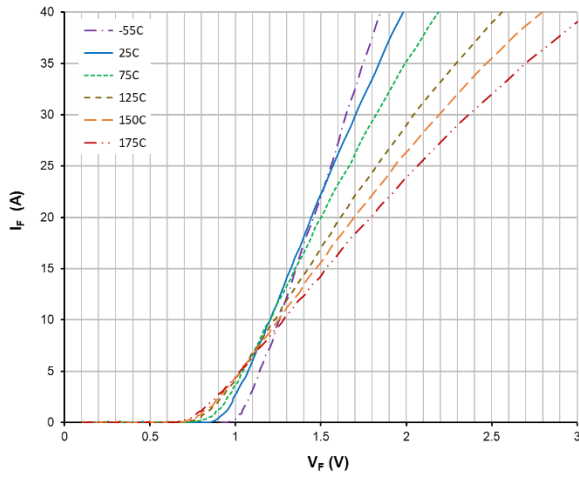

Figure 1. Forward Characteristics

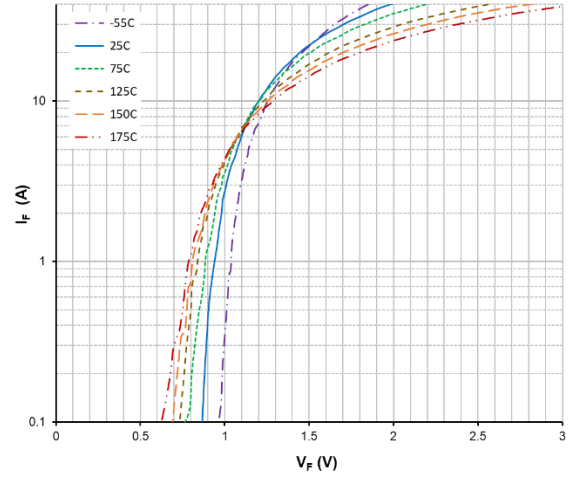

Figure 2. Forward Characteristics

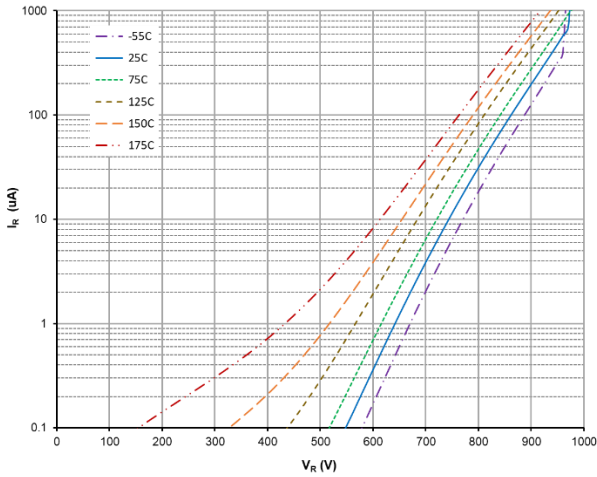

Figure 3. Reverse Characteristics

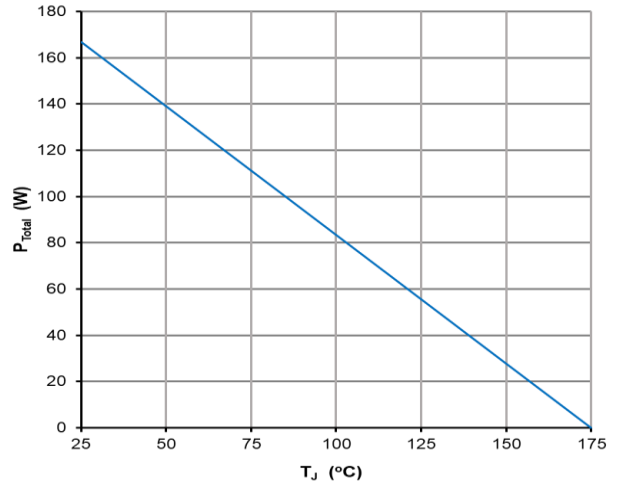

Figure 4. Power Derating

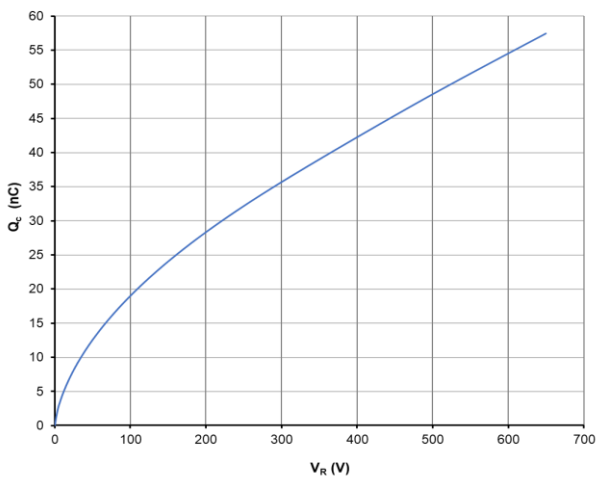

Figure 5. Capacitive charge vs. Reverse Voltage

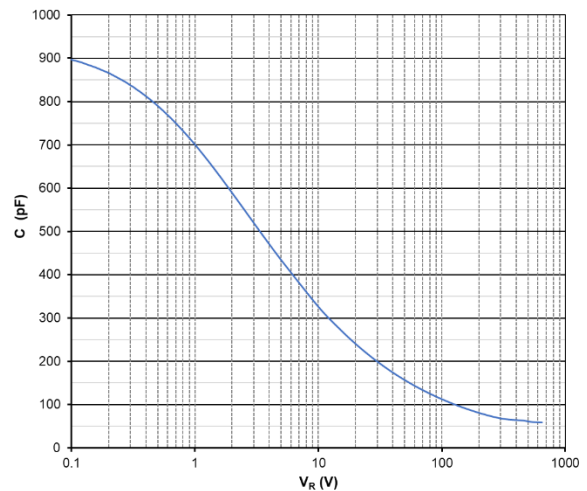
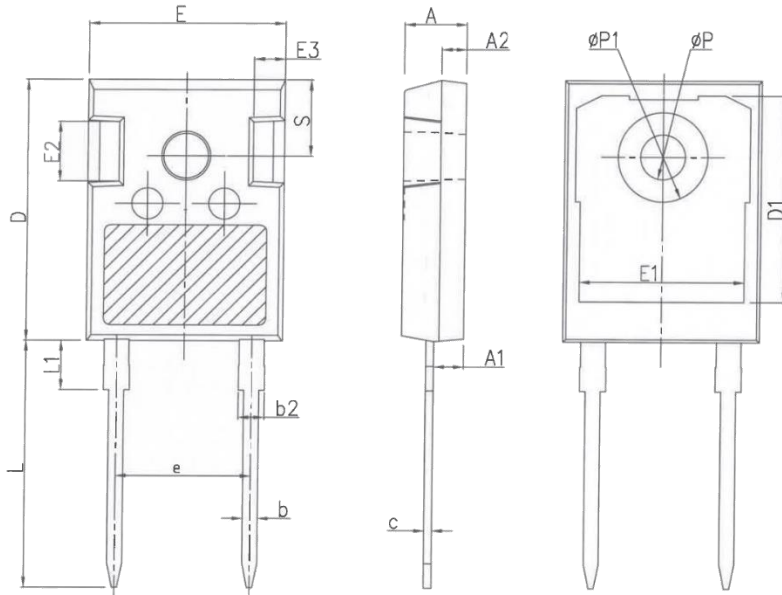

Figure 6. Capacitance vs. Reverse Voltage

## Package Dimensions

(TO-247-2 Package)



SYMBOL	mm	
	MIN.	MAX
A	4.8	5.20
A1	2.21	2.59
A2	1.85	2.15
b	1.11	1.36
b2	1.91	2.21
c	0.51	0.75
D	20.70	21.30
D1	16.25	16.85
E	15.50	16.10
E1	13.00	13.60
E2	4.80	5.20
E3	2.30	2.70
e	10.88BSC	
L	19.62	20.22
L1	-	4.30
phi P	3.4	3.80
phi P1	-	7.30
S	6.15BSC	

Part Number	Package	Packing	Marking
A5D20PS065AN	TO-247-2	30pcs / Tube	A5D20PS065AN